

General Conference Activity Packet

October 4 & 5, 2008
9:00 & 1:00 Both Days

PARENTS: These packets will hopefully enable you to listen to the messages of General Conference and encourage your children to watch Conference with you. We hope that the booklets will bless your families, especially on the Sabbath.

Come, Listen to a Prophet's Voice



Henry B. Eyring
1st Counselor



Thomas S. Monson
President



Dieter F. Uchtdorf
2nd Counselor

On the following pages, **write** a few notes or **draw** a picture about what these speakers talk about.
Color the tie to match what the speaker wore.

Circle your favorite talk and **write** something you will try to do better.

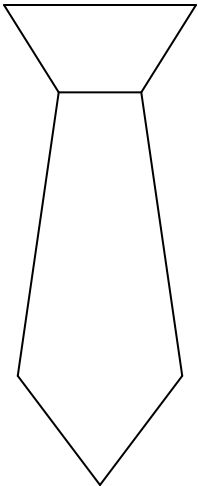

Thomas S. Monson
President

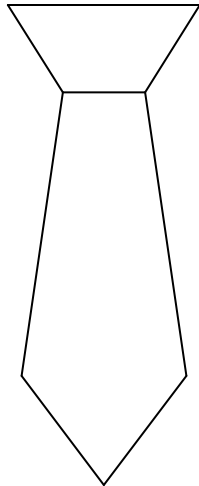

Henry B. Eyring
1st Counselor

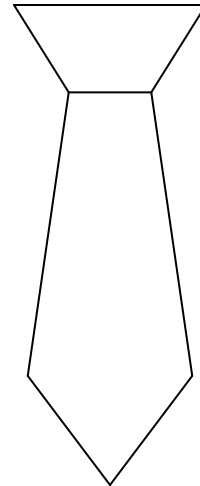

Dieter F. Uchtdorf
2nd Counselor

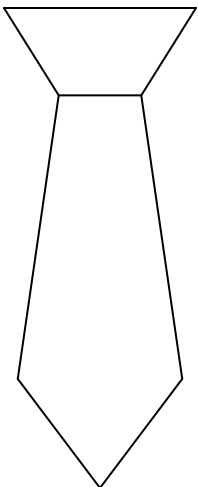

Boyd K. Packer
Pres. Quorum of
the 12 Apostles

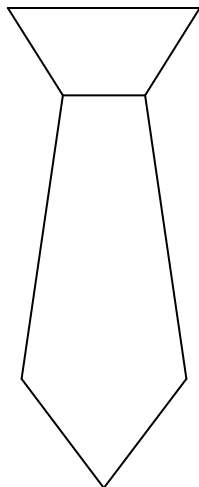

L. Tom Perry
Quorum of
the 12 Apostles

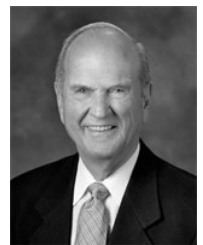
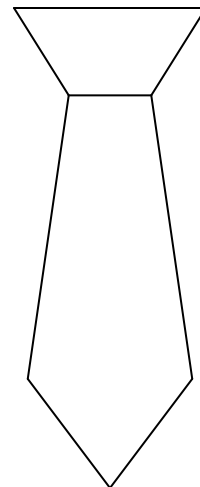

Russell M. Nelson
Quorum of
the 12 Apostles

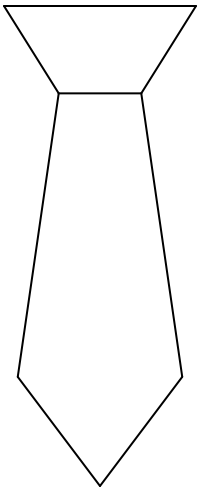

Dallin H. Oaks
Quorum of
the 12 Apostles

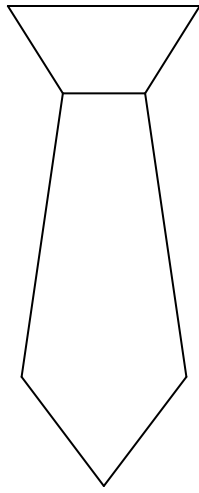

M. Russell Ballard
Quorum of
the 12 Apostles

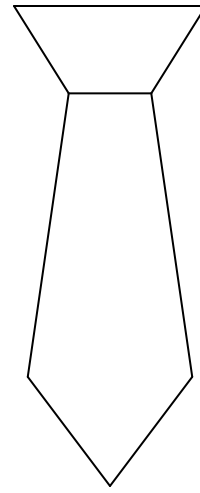

Joseph B. Wirthlin
Quorum of
the 12 Apostles

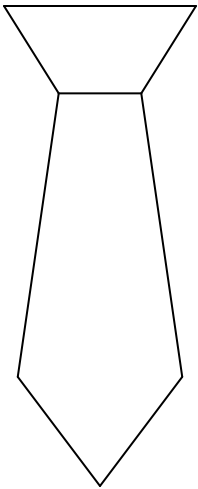

Richard G. Scott
Quorum of
the 12 Apostles

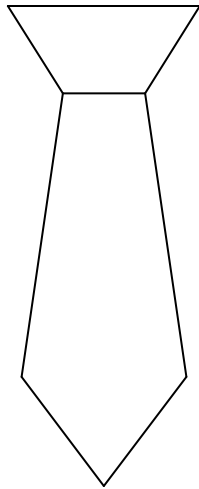

Robert D. Hales
Quorum of
the 12 Apostles

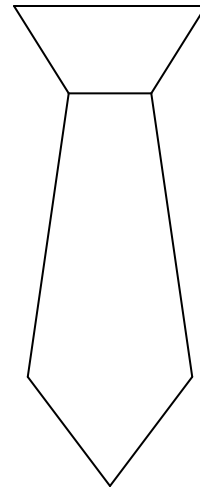

Jeffrey R. Holland
Quorum of
the 12 Apostles

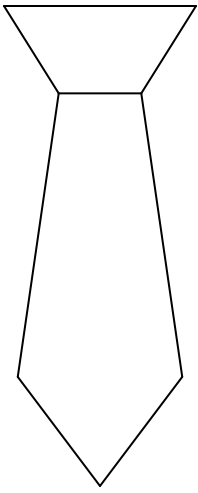

David A. Bednar
Quorum of
the 12 Apostles

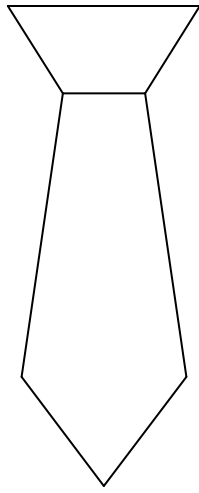

Quentin L. Cook
Quorum of
the 12 Apostles

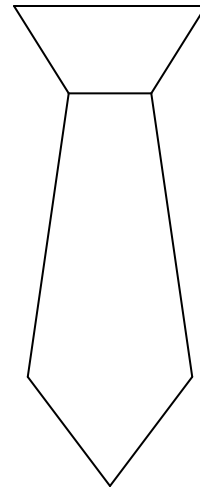

D. Todd Christopherson
Quorum of
the 12 Apostles

What songs did the choir sing?

Who conducted each session?

Saturday Morning _____

Saturday Afternoon _____

Sunday Morning _____

Sunday Afternoon _____

How many members of the Church are there? _____

What is the name of the building Conference is held in? _____

What is the Saturday night session called? _____

How many missions are there? _____

Were any new temples announced? If yes, where? _____



Find your way through the maze to our living prophet,
President Monson

♪ FOLLOW THE PROPHET ♪

Now we have a world where people are confused.
If you don't believe it, go and watch the news.
We can get direction all along our way,
If we heed the prophets—follow what they say.

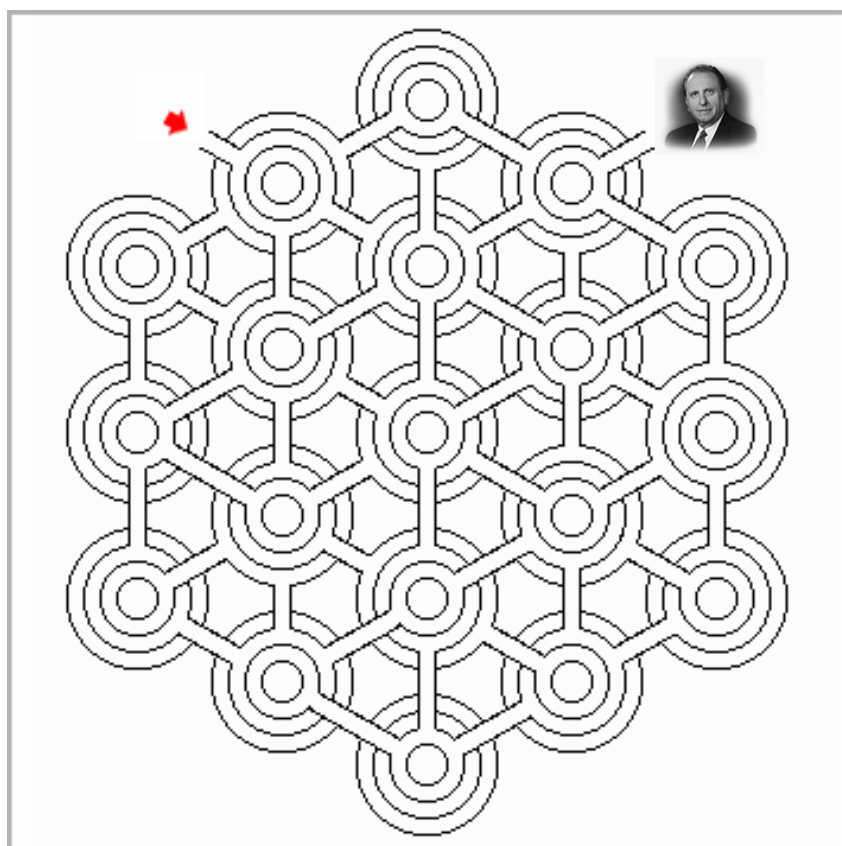



Draw a line from the name
to the correct picture.
Circle our Prophet's picture.

Thomas S. Monson

Boyd K. Packer

L. Tom Perry

Russell M. Nelson

Dallin H. Oaks

M. Russell Ballard

Joseph B. Wirthlin

Richard G. Scott

Robert D. Hales

Jeffrey R. Holland

Henry B. Eyring

Dieter F. Uchtdorff

David A. Bednar

Quentin L. Cook

D. Todd Christopherson



R	A	L	P	M	E	X	E	T	K	H	C
L	S	A	V	I	O	R	F	F	C	M	R
P	D	J	E	S	U	S	I	F	O	O	E
M	N	E	P	S	W	O	R	D	R	Q	A
E	S	H	L	K	C	N	S	L	E	J	T
S	S	O	K	I	N	G	T	I	D	U	O
S	T	V	N	R	V	R	B	G	E	D	R
I	L	A	M	B	N	E	O	H	E	G	B
A	C	H	R	I	S	T	R	T	M	E	R
H	O	L	Y	O	N	E	N	E	E	M	E
W	C	M	E	D	I	A	T	O	R	J	A
G	O	O	D	S	H	E	P	H	E	R	D

BREAD
EXEMPLAR
HOLY ONE
KING
MESSIAH
SON

CHRIST
FIRSTBORN
JEHOVAH
LAMB
REDEEMER
WORD

CREATOR
GOOD SHEPHERD
JESUS
LIGHT
ROCK

DELIVERER
JUDGE
MEDIATOR
SAVIOR

Seek
the
Words
of
Christ

Match the first name with the last name. Then, find the names in the word search.
Names are written forward, backward, up, down, and diagonally.

D Y E R L L A F N R L C I W
D O E M I I R O R N A H I S
O D E L L E S S U R M R P N
T A G U T L Y J H O T I A P
D V N E E A E N N H A S C E
T I I N D F I S L O C T K R
R D R D F L O I S O A O E R
E A Y R L N N T T U S F R Y
B T E A U C H T D O R F A O
O Y D L J O S E P H B E N N
R N C L M C R I C H A R D G
S D N A L L O H A L E S E L
L K S B Y R N E H E D O B T
O S A A N Q U E N T I N L O
K D Y O B F A H K O O C L M

Russell M	Monson
Richard G	Packer
Henry B	Perry
Thomas S	Nelson
Robert D	Oaks
Boyd K	Ballard
David A	Wirthlin
L Tom	Scott
Quentin L	Hales
Joseph B	Holland
Dallin H	Eyring
D Todd	Uchtdorf
M Russell	Bednar
Jeffrey R	Cook
Dieter F	Christofferson

Word Find: Find the last names of the apostles.
They will be found forward and up and down.

R K U C H T D O R F T I S
N C K H A L E S R H O O A
L W I R T H L I N E T L R
T W S I C S O H S E W F F
P O K S C O T T B K N T N
U I O T H T P P E R R Y M
C W H O L L A N D E N G I
F R O F C D C H N N R O H
N L T F O A K S A A P R O
A S T E O B E Y R I N G N
F T N R K F R N R L T O E
M O N S O N H R R R L N E
O D Y O B A L L A R D S A
D T H N E L S O N O L B S

Monson
Packer
Perry
Nelson
Oaks
Ballard
Wirthlin
Scott
Hales
Holland
Eyring
Uchtdorf
Bednar
Cook
Christofferson

Match the scripture with its reference.

“All human beings—male and female—are created in the image of God. Each is a beloved spirit son or daughter of heavenly parents, and, as such, each has a divine nature and destiny.”

Amos 3:7

“And if it so be that you should ... bring, save it be one soul unto me, how great shall be your joy.”

Mark 11:24

“And their children shall be baptized for the remission of their sins when eight years old, and receive the laying on of the hands.”

“For my soul delighteth in the scriptures, and my heart pondereth them, and writeth them for the learning and the profit of my children.”

1 John 4:14

2 Nephi 4:15

“Therefore I say unto you, What things soever ye desire, when ye pray, believe that ye receive them, and ye shall have them.”

“And we have seen and do testify that the Father sent the Son to be the Saviour of the world.”

2 Nephi 25:26

D&C 4:2

“Therefore, O ye that embark in the service of God, see that ye serve him with all your heart, might, mind and strength, that ye may stand blameless before God at the last day.”

“Surely the Lord God will do nothing, but he revealeth his secret unto his servants the prophets.”

D&C 18:15

D&C 59:7

“Thou shalt thank the Lord thy God in all things.”

“The family is central to the Creator’s plan for the eternal destiny of His children.”

D&C 68:27

D&C 124:40

“Proclamation,” paragraph 1

“And we talk of Christ, we rejoice in Christ, we preach of Christ, we prophesy of Christ, and we write according to our prophecies.”

“And verily I say unto you, let this house be built unto my name, that I may reveal mine ordinances therein unto my people.”

“Proclamation,” paragraph 2

General Conference Talk Subjects

During General Conference, the speakers will have many topics.

Here are many common subjects, circle them.

B O O K O F M O R M O N E K A M I S H L
 F O O D S T O R A G E P G C M A T E O U
 A S G E N W D J M O X R A O U L H L F P
 M C O M P A S S I O N E I M S I T P A B
 I R O N R O I H S G P P R M I Z A M T I
 L I D O E B W E S N M A R A C C E E H S
 I P W I P E F L I J I R A N O N D T E H
 E T O T E D O S O T R A M D V E U Y R O
 S U R C N I D G N P B T C M E R C T S P
 R R K E T E R N A L L I F E N D A S O E
 E E S R A N O I R D Z O T N A L T E P C
 H S R R N C W S I W J N N T N I I N D H
 C P E U C E Y S E P R I E S T H O O D R
 A S H S E L F E S T E E M O S C N H F I
 E M T E P S E L P M A X E H T A B B A S
 T Q O R R B I B L E F B N G N I H T I T
 U F M V A Q S P L H T U O Y W T M T T B
 J G V I Y O P R O P H E T L B T Y M H R
 K G L C E B A P V J P L A O T X X H O S
 P V K E R U D N E V Q H C H A S T I T Y

- | | | |
|----------------|--------------|----------------|
| Atonement | Examples | Preparation |
| Baptism | Faith | Priesthood |
| Bible | Families | Prophet |
| Bishop | Fathers | Repentance |
| Blessings | Food Storage | Resurrection |
| Book of Mormon | Good Works | Sabbath |
| Chastity | Holy Ghost | Scriptures |
| Children | Honesty | Self-Esteem |
| Christ | Hope | Service |
| Commandment | Love | Teachers |
| Compassion | Marriage | Temples |
| Covenants | Missionaries | Tithing |
| Death | Mothers | Word of Wisdom |
| Education | Music | Youth |
| Endure | Obedience | |
| Eternal Life | Prayer | |

The Living Prophets

Use the clues below to fill in the last names of our Living Prophets.

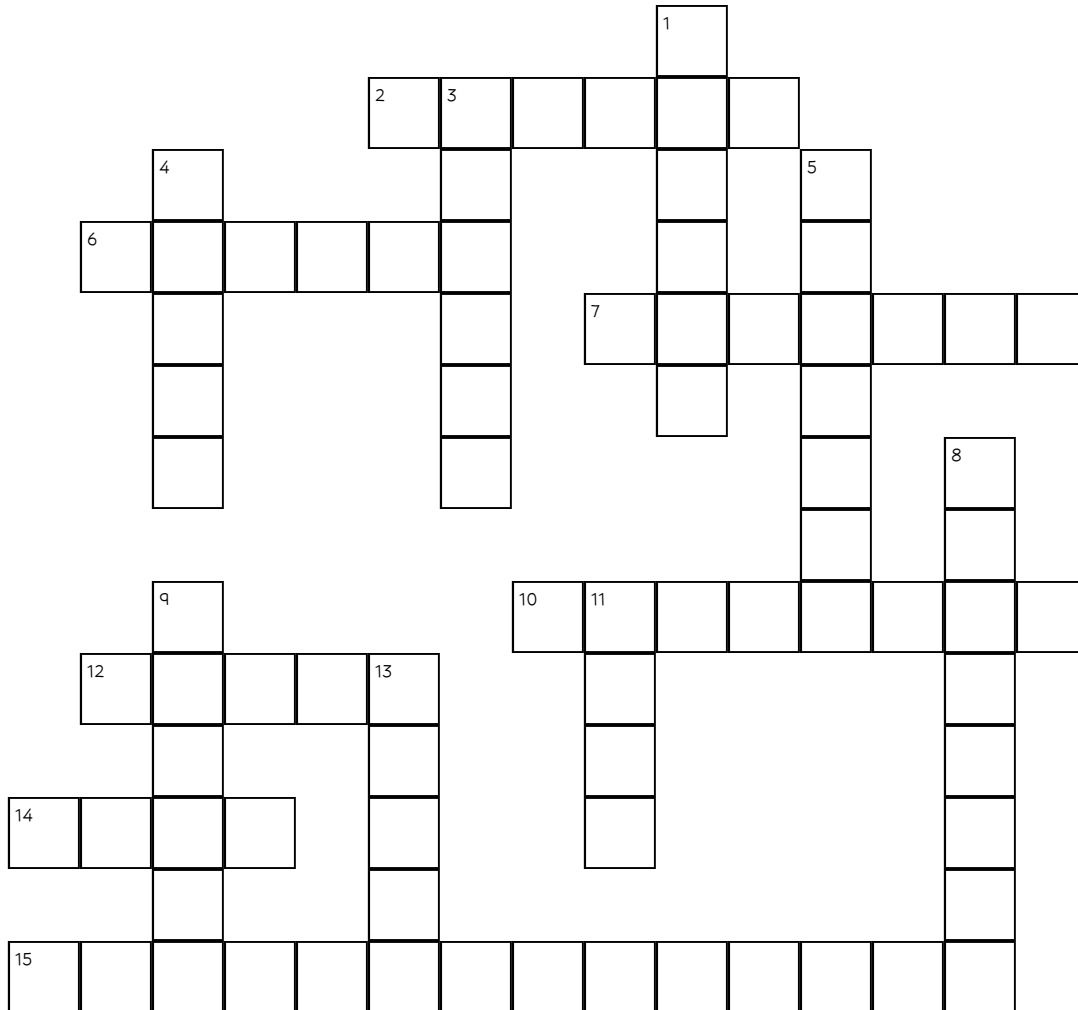

ACROSS

- 2 RUSSELL M.
- 6 DAVID A.
- 7 JEFFREY R.
- 10 DIETER F.
- 12 ROBERT D.
- 14 DALLIN H.
- 15 D. TODD















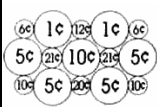









DOWN

- 1 THOMAS S.
- 3 HENRY B.
- 4 L. TOM
- 5 M. RUSSELL
- 8 JOSEPH B.
- 9 BOYD K.
- 11 QUENTIN L.
- 13 RICHARD G.

Use the key to discover a hidden message.

A	⌵	H	⊗	O	✎	V	✕
B	✂	I	✈	P	✎	W	✕
C	✂	J	✉	Q	✎	X	✕
D	✂	K	☞	R	☞	Y	✕
E	✂	L	☞	S	☞	Z	+
F	☎	M	✌	T	✓	,	■
G	☎	N	✍	U	✓	.	!!



 Jesus Christ	 Word of Wisdom	 Scriptures	 Missionaries	 Atonement
 Tithing	 Family	 Temple	 Joseph Smith	 Hymns
 Baptism	 Resurrection	 FREE	 Holy Ghost	 Prayer
 CTR	 Sacrament	 Pioneers	 Prophet	 Priesthood
 Faith	 Love	 Bishop	 Commandments	 Home

BINGO!!!
They said it!

Listen carefully to what each speaker says. If you see their topic cover it with a bean, M&M, Skittle, piece of paper, whatever you can find! Try to get five in a row (up and down, sideways, or diagonally), corners, or blackout! But you need to listen carefully so you don't miss anything!



Joseph Smith Saw Heavenly Father
and Jesus Christ



I Am a Child of God

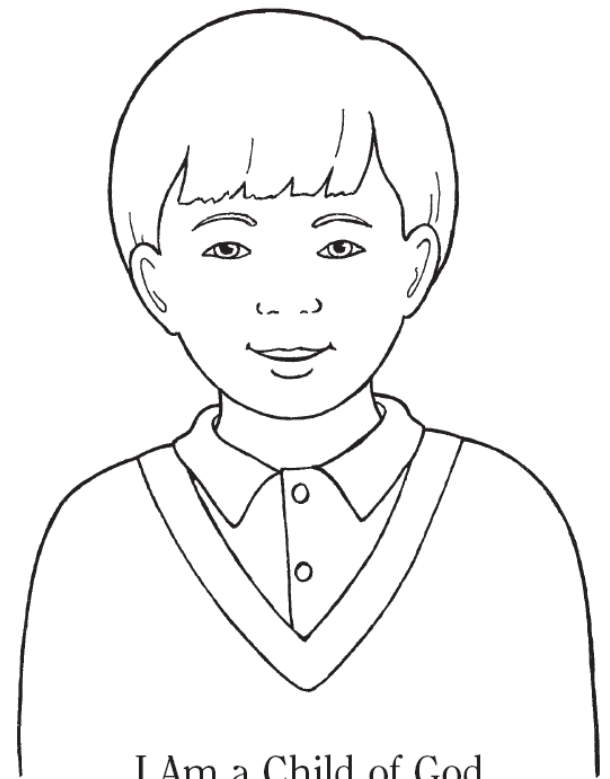
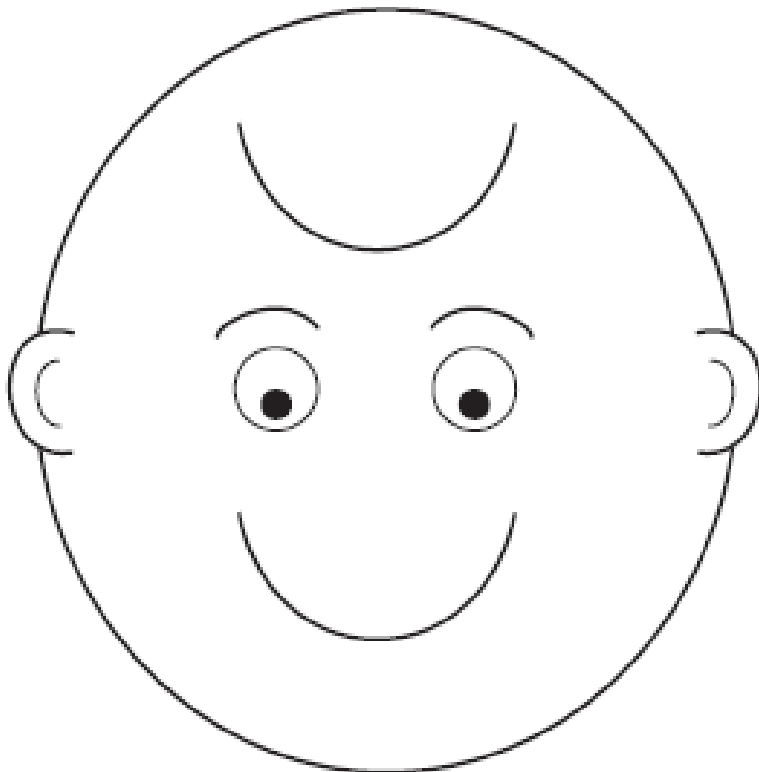

I Am a Child of God

I Belong to The Church of Jesus Christ of Latter-day Saints



The Church of Jesus Christ
has prophets.

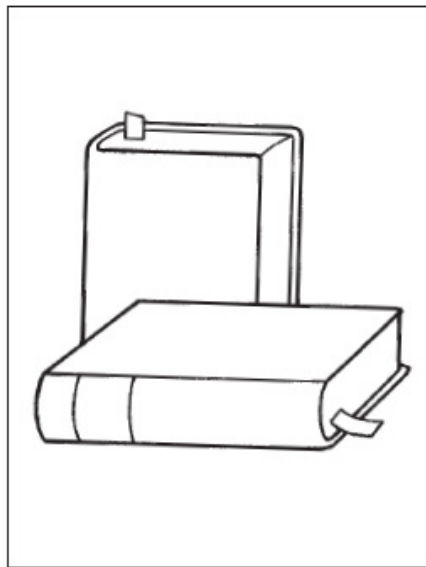

The Church of Jesus Christ
has scriptures.



FAMILY